

Catalogo generale ricambi

General spare parts catalogue

Catalogue générale des pièces de rechange

Ersatzteile-katalog

Catálogo de piezas



Battioni®
Pagani

Setting the pace since 1953

2021



Battioni®
Pagani

FORCED LUBRICATION MEC 2000-3000-4000-5000

Rev. 0 - 01/05/2021

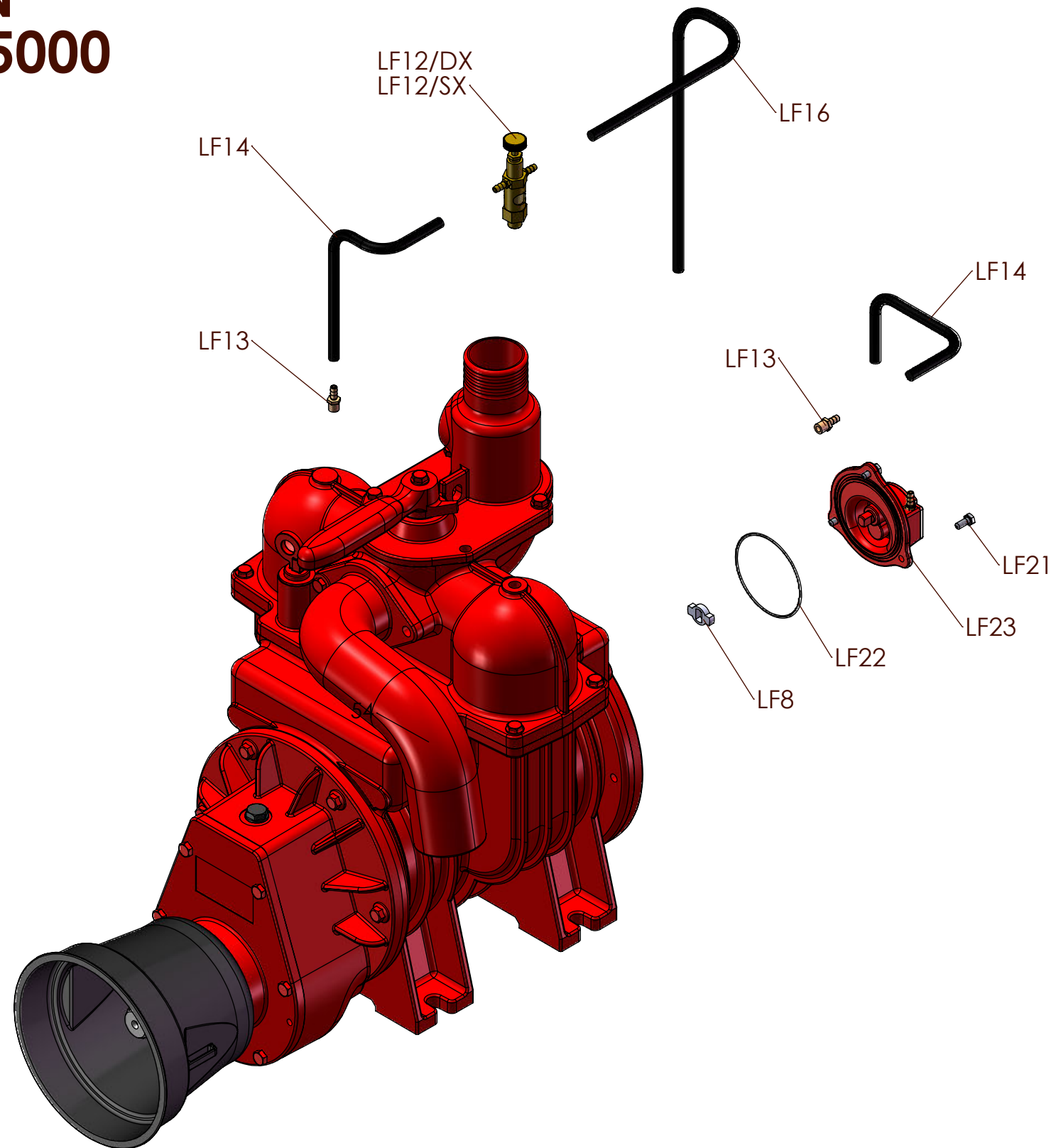



Battioni®
Pagani

AUTOMATIC LUBRICATION MEC 1000-1600-2000-3000-4000-5000

Rev. 0 - 01/05/2021

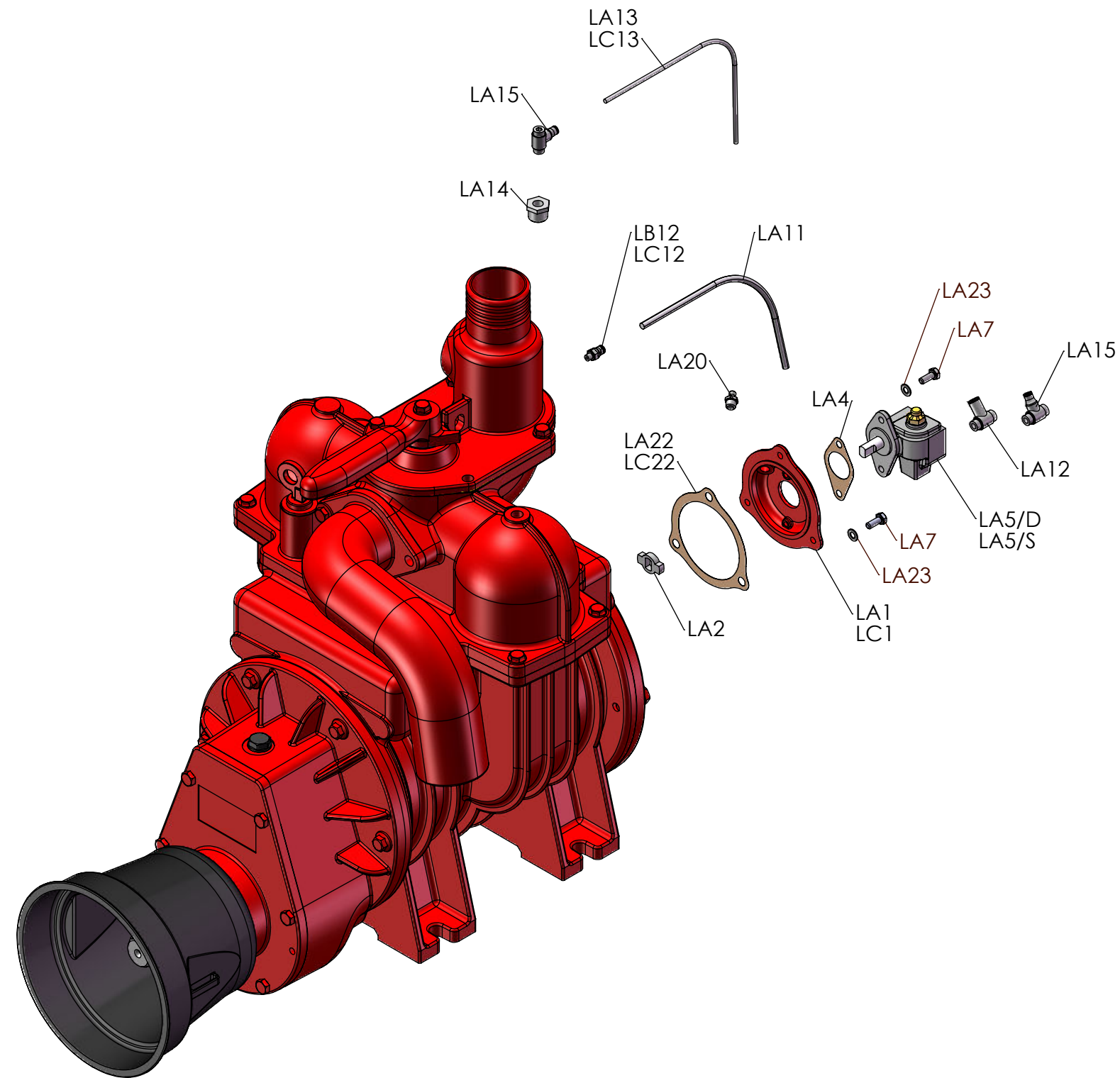



Battioni®
Pagani

FORCED LUBRICATION MEC 6500-8000

Rev. 0 - 01/05/2021

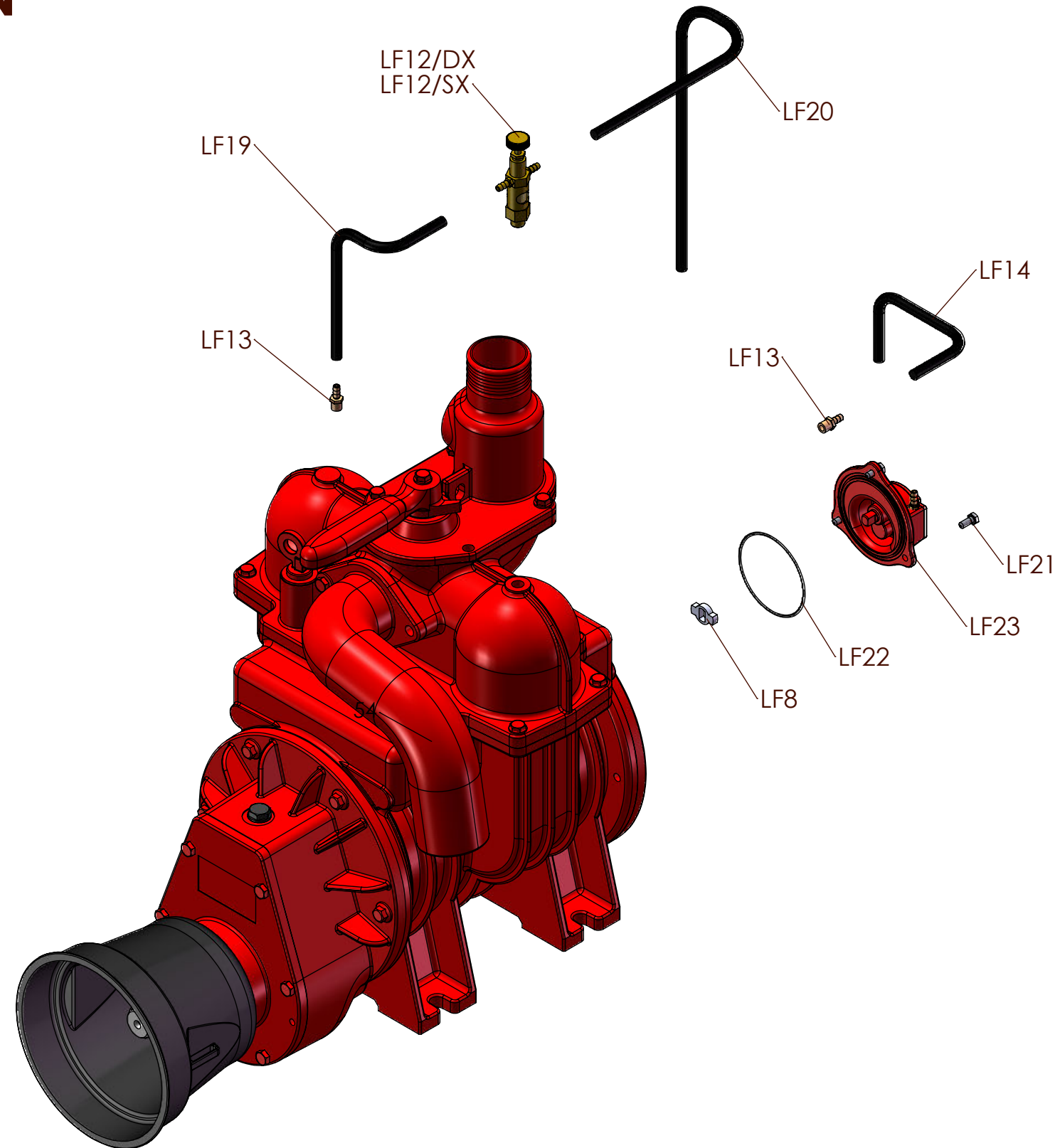



Battioni®
Pagani

AUTOMATIC LUBRICATION MEC 6500-8000

Rev. 0 - 01/05/2021

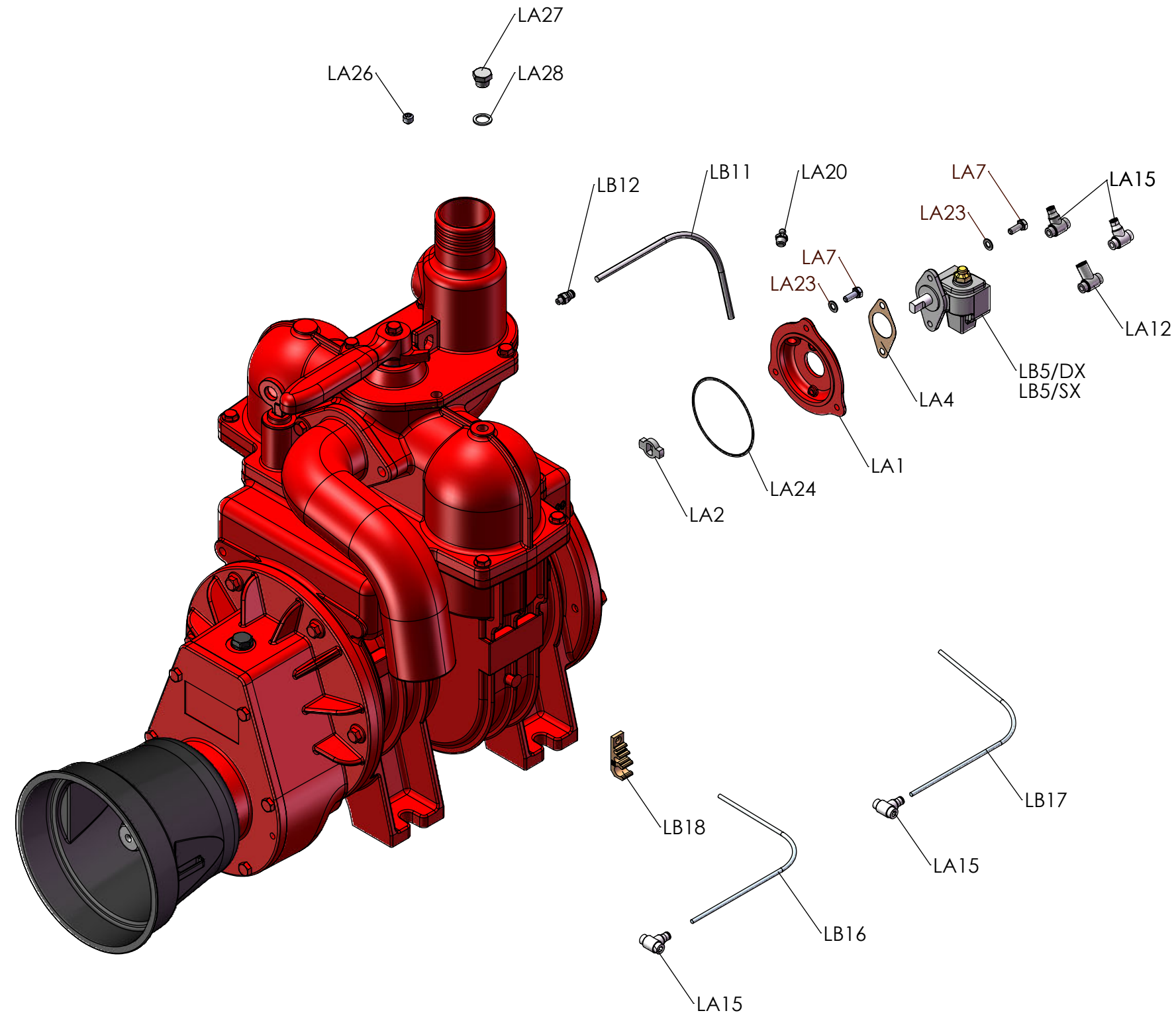



Battioni®
Pagani

Forced lubrication MEC 9000-11000-13500

Rev. 0 - 01/05/2021

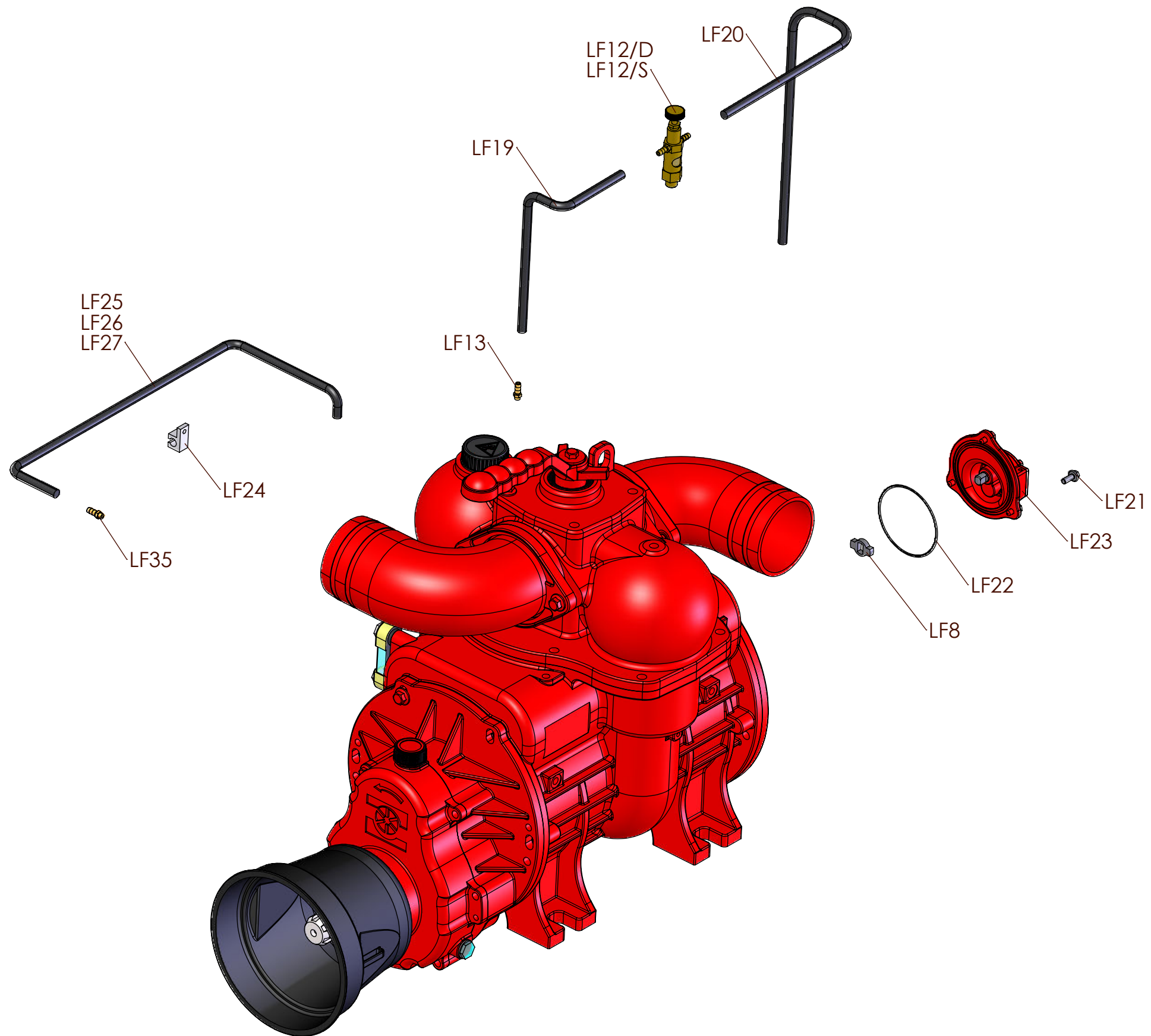



Battioni®
Pagani

Automatic lubrication MEC 9000-11000-13500

Rev. 0 - 01/05/2021

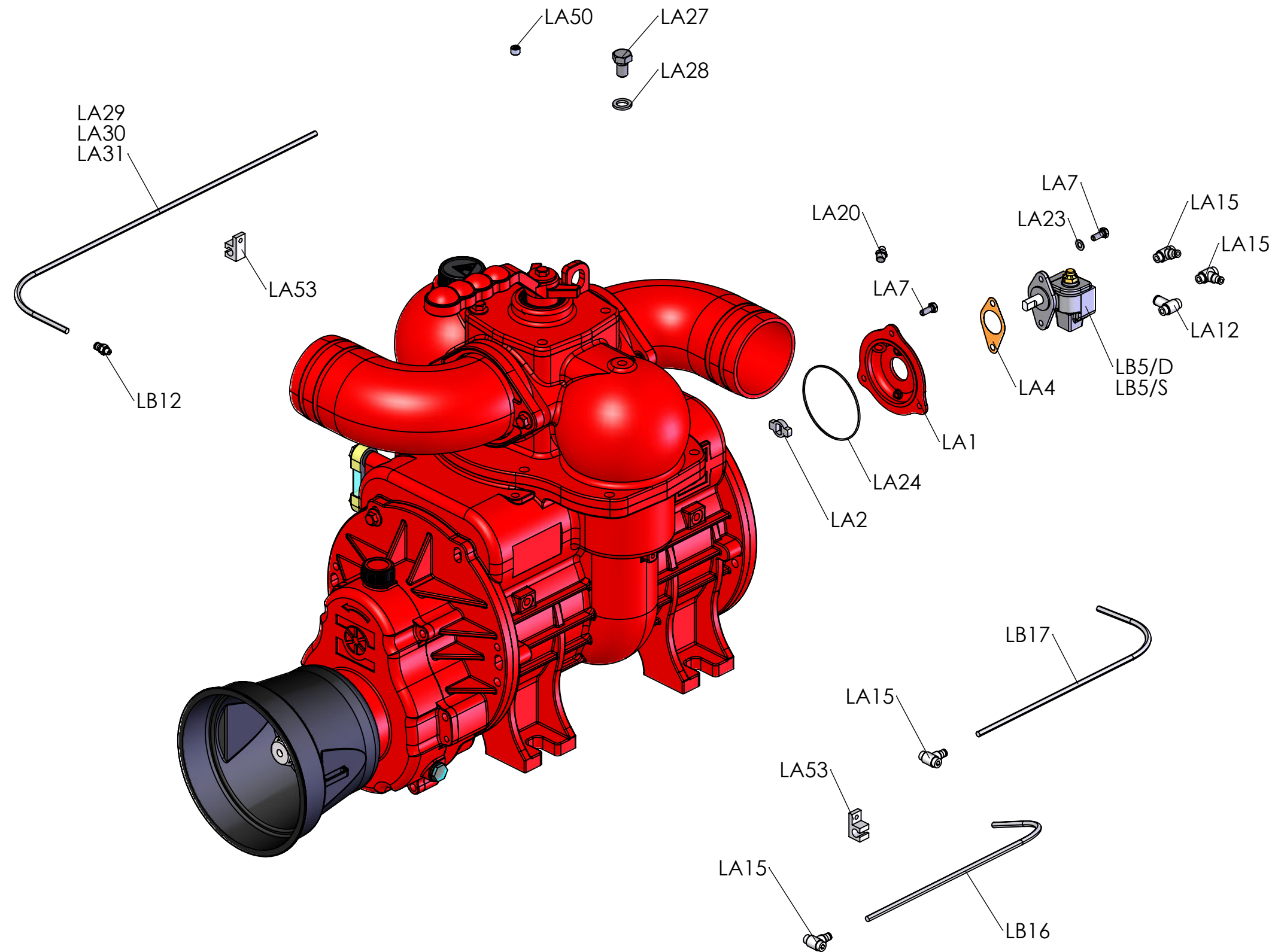



Battioni®
Pagani

MEC 9000-11000-13500 L.F. with side oil tank

Rev. 0 - 03/06/2020

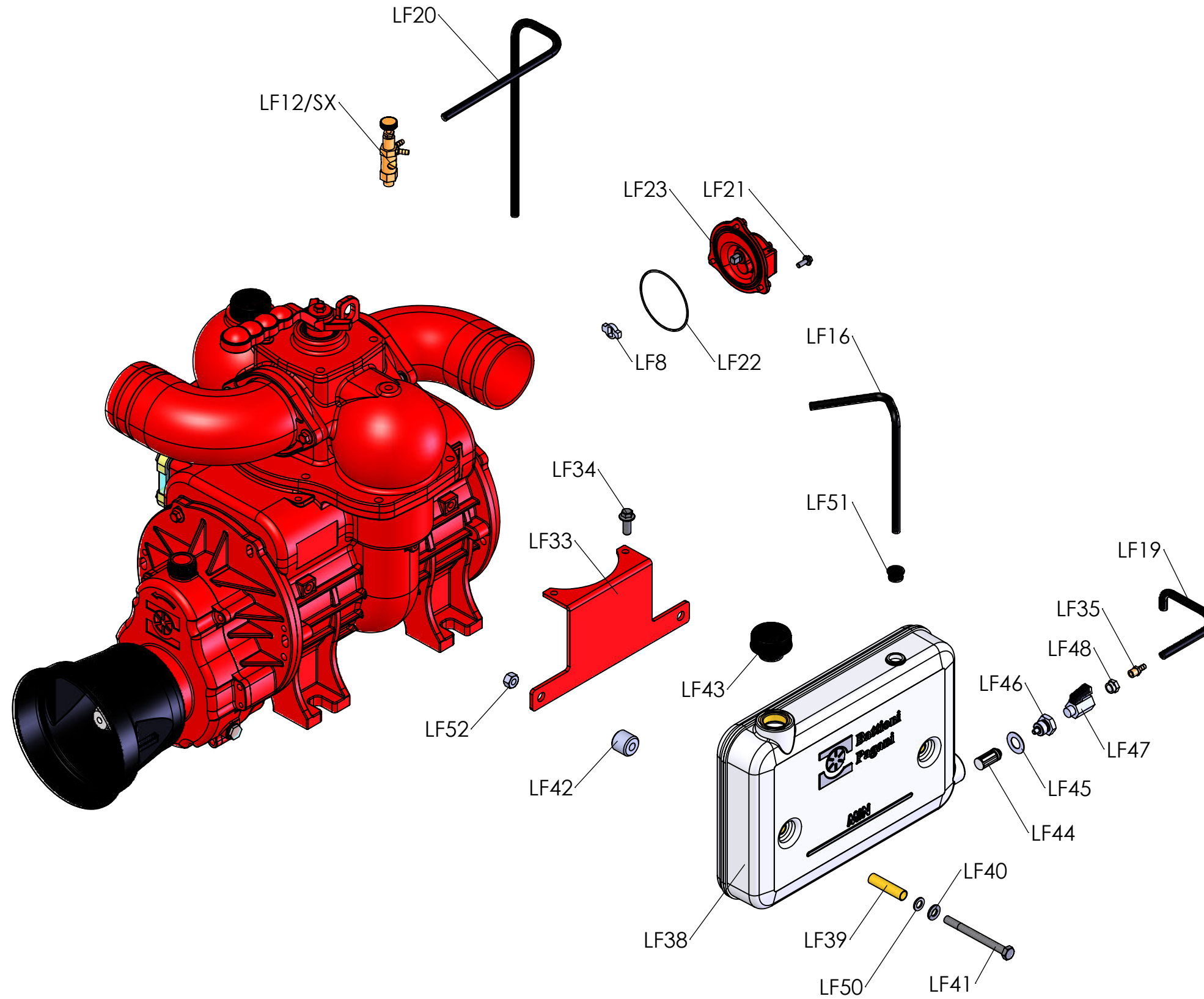



Battioni®
Pagani

Automatic lubrication MEC 9000-11000-13500 with side oil tank

Rev. 0 - 01/03/2021

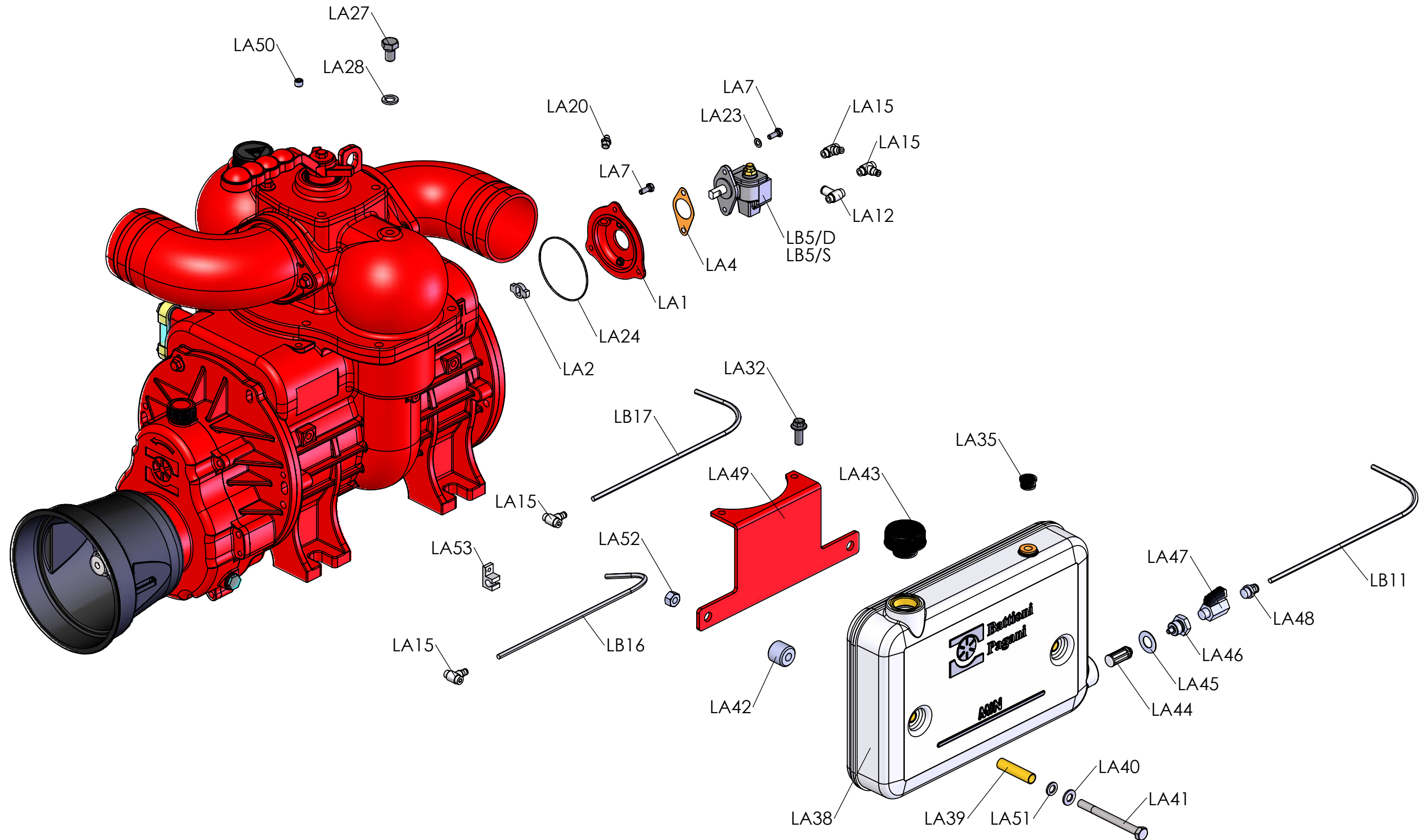

CODE	ARTICLE	DESCRIZIONE	DESCRIPTION	Q.TY	UM
LA1	4010601022	COPERCHIO POSTERIORE POMPA OLIO MEC LA	OIL PUMP SUPPORT BACK COVER - MEC L.A.	1	n
LA2	4010006002	GIUNTO DI COLLEGAMENTO L.F.	CONNECTOR JOINT - L.F.	1	n
LA4	4030108011	GUARN. POMPA OLIO L.A.	OIL PUMP GASKET - L.A.	1	n
LA5/DX	5080200033	POMPA LA 1 MAND. AL DX IIS	OIL PUMP - LA 1 WAYS AL DX IIS	1	n
LA5/SX	5080200034	POMPA LA 1 MAND. AL SX IIS	OIL PUMP - LA 1 WAYS AL SX IIS	1	n
LA7	5050107005	VITE M 6X16 TE	SCREW - M 6X16 TE	5	n
LA11	5080105002	TUBO LUBRIFICAZIONE D 4X6 - RILSAN	SUCTION HOSE - D 4X6 RILSAN	0,24	m
LA12	5040303007	RACCORDO D 1/8"X6X90° RILSAN	CONNECTOR - D 1/8"X6X90° RILSAN	2	n
LC12	5040303027	RACCORDO DRITTO D 1/8"X6 RILSAN - F.CON.	STRAIGHT CONNECTOR - D 1/8"X6 RILSAN	1	n
LA13	5080105001	TUBO LUBRIFICAZIONE D 2X4 - RILSAN	LUBRICATION HOSE - D 2X4 RILSAN	0,47	m
LA14	5040407001	RIDUZIONE D 1/4"X1/8" GAS	REDUCTION - D 1/4"X1/8" GAS	1	n
LA15	5040303008	RACCORDO D 1/8"X4X90° RILSAN	CONNECTOR - D 1/8"X4X90° RILSAN	4	n
LA20	5050812001	INGRASSATORE M 10X1	LUBRICATOR - M 10X1	1	n
LA22	4030108005	GUARN. COPERCHIO POSTERIORE MEC 2-8000	BACK COVER GASKET - MEC 2-8000	1	n
LA23	5050207002	RONDELLA D 6	SMOOTH WASHER - D 6	5	n
LA24	5030210028	ANELLO TENUTA OR 2337 POMPA LF	SEAL RING - OR 2337 LF PUMP	1	n
LA25	5080004004	FASCETTA STRINGITUBO D 6 LA	HOSE CLAMP - D 6 LA	1	n
LA26	5050903001	TAPPO M 10x1 - DIN 906	PLUG M 10x1 DIN 906	1	n
LA27	5050906001	TAPPO D 1/4" GAS	PLUG - D 1/4" GAS	1	n
LA28	5050202003	RONDELLA D 1/4" GAS ALLUMINIO	ALUMINIUM WASHER - D 1/4" GAS	1	n
LA29	5080105003	TUBO LUBRIFICAZIONE D4X6 TEFLON-MEC9000	SUCTION HOSE - D 4X6 TEFLON - MEC9000	0,5	m
LA30	5080105003	TUBO LUBRIFICAZIONE D4X6 TEFLON-MEC11000	SUCTION HOSE - D 4X6 TEFLON - MEC11000	0,55	m
LA31	5080105003	TUBO LUBRIFICAZIONE D4X6 TEFLON-MEC13500	SUCTION HOSE - D 4X6 TEFLON - MEC13500	0,6	m
LA32	5050107108	VITE M 8X25 TEF - FL/ZIGR 8.8 -	SCREW - M 8X25 TEF - FL/ZIGR 8.8	2	n
LA35	4060310001	PASSATUBO CHIUSO	CLOSED RUBBER FITTING	1	n
LA38	4011406012	SERBATOIO OLIO STAMPATO	OIL TANK THERMOFORMED	1	n
LA39	4011707113	INSERTO OTTONE SERBATOIO PLASTICA	INSERT BRASS PLASTIC OIL TANK	2	n
LA40	5050207024	RONDELLA D 10 ZINCATA	GALVANIZED FLAT WASHER - D 10	2	n
LA41	5050107025	VITE M 10X100 TE	SCREW - M 10X100 TE	2	n
LA42	4011707112	DISTANZIALE SERBATOIO PLASTICA	SPACER FOR PLASTIC TANK	2	n
LA43	5060605014	TAPPO CARICO OLIO D 1" GAS	CHARGE OIL PLUG - D 1" GAS	1	n
LA44	5080005001	FILTRO OLIO WPT LA	OIL FILTER - WPT LA	1	n
LA45	5050202004	RONDELLA D 1/2" GAS ALLUMINIO	ALUMINIUM WASHER - D 1/2" GAS	1	n
LA46	4040407001	RIDUZIONE PORTAFILTRO WPT LA	FILTER REDUCTION - WPT LA	1	n
LA47	5040200001	RUBINETTO SERBATOIO OLIO D 1/4" GAS	OIL TANK DRAIN COCK - D 1/4" GAS	1	n
LA48	5040303015	RACCORDO DRITTO D 1/4"X6 RILSAN	CONNECTOR - R1 1/4"X6	1	n
LA49	4010007061	SUPPORTO SERBATOIO PLASTICA MEC9-13500	SIDE PLASTIC TANK SUPPORT - MEC 9-13500	1	n
LA50	5050903003	TAPPO D. 1/8" - DIN 906	PLUG - D 1/8" DIN 906	1	n
LA51	4060310005	RONDELLA IN GOMMA	RUBBER WASHER	2	n
LB5/DX	5080200036	POMPA LA 2 MAND. AL DX IIS	OIL PUMP - LA 2 WAYS AL DX IIS	1	n
LB5/SX	5080200038	POMPA LA 2 MAND. AL SX IIS	OIL PUMP - LA 2 WAYS AL SX IIS	1	n
LB11	5080105002	TUBO LUBRIFICAZIONE D 4X6 - RILSAN	SUCTION HOSE - D 4X6 RILSAN	0,26	m
LB12	5040303011	RACCORDO DRITTO D 1/8"X6 RILSAN	STRAIGHT CONNECTOR - D 1/8"X6 RILSAN	1	n
LB16	5080105001	TUBO LUBRIFICAZIONE D 2X4 - RILSAN	LUBRICATION HOSE - D 2X4 RILSAN	0,69	m
LB17	5080105001	TUBO LUBRIFICAZIONE D 2X4 - RILSAN	LUBRICATION HOSE - D 2X4 RILSAN	0,29	m
LB18	4010007080	SOSTEGNO TUBI TERMOPLASTICO	THERMOPLASTIC SUPPORT HOSE	1	n
LC1	4010606017	COPERCHIO POSTERIORE MEC 1000-1600 LA	BACK COVER - MEC 1000-1600 LA	1	n
LC12	5040303027	RACCORDO DRITTO D 1/8"X6 RILSAN - F.CON.	STRAIGHT CONNECTOR - D 1/8"X6 RILSAN C.T	1	n
LC13	5080105001	TUBO LUBRIFICAZIONE D 2X4 - RILSAN	LUBRICATION HOSE - D 2X4 RILSAN	0,42	m
LC22	4030108002	GUARN. COPERCHIO POSTERIORE MEC 1-1600	BACK COVER GASKET - MEC 1-1600	1	n
LF8	4010006002	GIUNTO DI COLLEGAMENTO L.F.	CONNECTOR JOINT - L.F.	1	n
LF12/DX	5040200003	RUBINETTO REGOLATORE OLIO 2 VIE X 180°	DRAIN COCK - 2 WAYS X 180°	1	n
LF12/SX	5040200007	RUBINETTO REGOLATORE OLIO 2 VIE X 60°	DRAIN COCK - 2 WAYS X 60°	1	n
LF13	5040303004	RACCORDO PORTATUBO M10X1 LF	CONNECTOR M10X1 LF	2	n
LF14	5080110002	TUBO IN GOMMA D 5X11	RUBBER HOSE - D 5X11	0,17	m
LF16	5080110002	TUBO IN GOMMA D 5X11	RUBBER HOSE - D 5X11	0,4	m
LF19	5080110002	TUBO IN GOMMA D 5X11	RUBBER HOSE - D 5X11	0,21	m
LF20	5080110002	TUBO IN GOMMA D 5X11	RUBBER HOSE - D 5X11	0,47	m

CODE	ARTICLE	DESCRIZIONE	DESCRIPTION	Q.TY	UM
LF21	5050107005	VITE M 6X16 TE	SCREW - M 6X16 TE	3	n
LF22	5030210028	ANELLO TENUTA OR 2337 POMPA LF	SEAL RING - OR 2337 LF PUMP	1	n
LF23	6080200001	POMPA LF MEC 2-8000 COMPLETA	PUMP - LF MEC 2-8000 FULL	1	n
LF24	5080004003	FASCETTA STRINGITUBO D 10 LF	HOSE CLAMP - D 10 LF	1	n
LF25	5080110002	TUBO DI ASPIRAZIONE 5X11 - MEC9000	RUBBER HOSE 5X11 - MEC9000	0,5	m
LF26	5080110002	TUBO DI ASPIRAZIONE 5X11 - MEC11000	RUBBER HOSE 5X11 - MEC11000	0,55	m
LF27	5080110002	TUBO DI ASPIRAZIONE 5X11 - MEC13500	RUBBER HOSE 5X11 - MEC13500	0,6	m
LF29	5060605007	TAPPO CARICO OLIO D 1"1/4 GAS	OIL PLUG - D 1"1/4 GAS	1	n
LF32	5060105003	LIVELLO OLIO COMPLETO SLV 127	COMPLETE OIL LEVEL - SLV 127	1	n
LF33	4011001074	SUPPORTO SERBATOIO LATER. MEC 9-11-13500	SIDE TANK SUPPORT - MEC 9-11-13500	1	n
LF34	5050107108	VITE M 8X25 TEF - FL/ZIGR 8.8 -	SCREW - M 8X25 TEF - FL/ZIGR 8.8	2	n
LF35	5040303029	RACCORDO PORTATUBO 1/8" GAS LF	CONNECTOR - D 1/8" GAS LF	2	n
LF38	4011406012	SERBATOIO OLIO STAMPATO	OIL TANK THERMOFORMED	1	n
LF39	4011707113	INSERTO OTTONE SERBATOIO PLASTICA	INSERT BRASS PLASTIC OIL TANK	2	n
LF40	5050207024	RONDELLA D 10 ZINCATA	GALVANIZED FLAT WASHER - D 10	2	n
LF41	5050107025	VITE M 10X100 TE	SCREW - M 10X100 TE	2	n
LF42	4011707112	DISTANZIALE SERBATOIO PLASTICA	SPACER FOR PLASTIC TANK	2	n
LF43	5060605014	TAPPO CARICO OLIO D 1" GAS	CHARGE OIL PLUG - D 1" GAS	1	n
LF44	5080005001	FILTRO OLIO WPT LA	OIL FILTER - WPT LA	1	n
LF45	5050202004	RONDELLA D 1/2" GAS ALLUMINIO	ALUMINIUM WASHER - D 1/2" GAS	1	n
LF46	4040407001	RIDUZIONE PORTAFILTRO WPT LA	FILTER REDUCTION - WPT LA	1	n
LF47	5040200001	RUBINETTO SERBATOIO OLIO D 1/4" GAS	OIL TANK DRAIN COCK - D 1/4" GAS	1	n
LF48	5040407001	RIDUZIONE D 1/4"X1/8" GAS	REDUCTION - D 1/4"X1/8" GAS	1	n
LF49	4010007061	SUPPORTO SERBATOIO PLASTICA MEC9-13500	SIDE PLASTIC TANK SUPPORT - MEC 9-13500	1	n
LF50	4060310005	RONDELLA IN GOMMA	RUBBER WASHER	2	n
LF51	4060310001	PASSATUBO CON FORO Ø 10	Ø 10 RUBBER FITTING	1	n



Battioni®
Pagani

Setting the pace since 1953

0	01.05.2021	1° EMISSIONE	PROG	R DT	AM
REV.	DATA	MOTIVO	PREPARATO	APPROVATO	AUTORIZZATO



Battioni®
Pagani

Setting the pace since 1953

Via Cav. Enzo Ferrari, 2
43058 Ramoscello di Sorbolo (PR) - Italy

Ph. +39 0521 663203

Fax +39 0521 663206



www.bapag.it
info@bapag.it